

# Framery One Compact™



The smart and soundproof office phone booth  
shaping the workspace of tomorrow



Framery One Compact is a smart, spacious, one-person phone booth designed for phone and video calls. This state-of-the-art soundproof office pod is packed with technology, featuring world-class sound insulation, echo-free acoustics, adaptive ventilation and automated lighting – so you can focus on your calls and connect online with people anywhere.

## Framery One Compact / Product highlights



### Workdays that flow with ease

Framery One Compact has been purposefully designed to make your workdays flow better. Find and book the pod in advance or on-the-fly from the Framery app. Or step inside and the pod automatically creates a reservation for you. Extend your reservation directly from the pod's touchscreen, or adjust your booking through the app.



### Privacy you can trust

The fine-tuned acoustic structure provides A-Class soundproofing that allows the pod to be placed next to workstations without causing noise distractions to the user or to those outside of the pod. And echo-free interior acoustics make the pod a private, comfortable place for work and video calls.



### Airflow that keeps you fresh

The pod recognizes when it's occupied, senses the temperature and humidity of the surroundings, and triggers adjustments to the airflow accordingly. Enhanced ventilation fully refreshes the air every minute, and ventilation can be easily adjusted through the pod's touchscreen display.



### Lighting that makes you feel good

Automated dual-lighting sources adapt to your needs, with preset lighting options to choose between work or video modes. Video-optimized lighting helps you shine on video calls. Adjustments can be made quickly and easily through the touchscreen display.

## Framery One Compact / Tech features



### 1. A-CLASS SOUNDPROOFING

Guaranteed privacy with fine-tuned Class A speech level reduction of 30dB – and the industry's top ISO 23351-1 rating for office phone booths.

### 2. FRAMERY OFFICE SOUND MASKING SYSTEM™

The embedded system is based on patent-pending technology that reduces noise distractions and protects speech privacy in office environments by adding a subtle, unobtrusive background sound outside of the pod. This ambient background noise, similar to air flow, is specifically designed to blend in with the office's noise atmosphere – making sounds less intelligible and therefore less distracting.

### 3. ADAPTIVE VENTILATION

Proprietary design enables unparalleled ventilation with maximum airflow of 36 l/s – surpassing industry standards around the world.

### 4. TEMPERATURE & HUMIDITY SENSORS

Sensors inside the pod recognizes the temperature and humidity of the office environment, and automatically optimizes the airflow accordingly.

### 5. AUTOMATIC LIGHTING MODES

Dual adjustable 4000K LED light sources allow you to seamlessly switch between video or work modes – or make manual adjustments for personalized illumination.

### 6. 8-INCH TOUCHSCREEN

An intuitive, 8-inch high-resolution touchscreen makes it easy to control pod settings, adjust lighting and airflow, and extend calendar reservations effortlessly.

### 7. AUTOMATIC UPGRADES

A built-in 4G connection enables automatic over-the-air software updates - initiated instantly and silently in the background.

### 8. MMWAVE RADAR PRESENCE DETECTION

Millimeter-wave radar sensors immediately detect when someone enters or leaves the pod, allowing lighting and ventilation to adjust accordingly.

Occupancy data is gathered and displayed through Framery Connect to provide information about when the pod is being used the most.

### 9. FRAMERY CONNECT™

Gain insights from occupancy data, initiate advanced bookability functionalities, and connect your Framery One Compact to the entire office to get valuable usage data needed to improve the layout and efficiency of your workplace.

---

## Framery One Compact / Design details

Framery One Compact feels spacious inside while taking a minimal amount of floor space. This phone booth is built to last with a lightweight structure and efficient use of materials without compromising performance or quality. The minimalistic design approach uses carefully curated materials, making it a sustainable choice.



A custom-designed table comfortably fits a laptop. A built-in power outlet, USB-C port, and inset bag hook keep your office accessories within reach. The height-adjustable seat and built-in footrest prioritize comfortable and ergonomic working positions. An adjustable video light casts a soft, natural glow on the user's face.



Spatial efficiency within the office is maximized with a minimal footprint (1.03m<sup>2</sup> / 11.1 ft<sup>2</sup>) while providing a spacious interior. Easily relocate the pod without the need for disassembly with the optional movability kit.



The top-mounted occupancy lights show at a glance whether the pod is available or already taken.

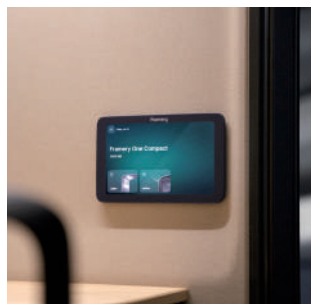

A built-in UI panel puts you in control of the pod's lighting, ventilation, and reservation status.

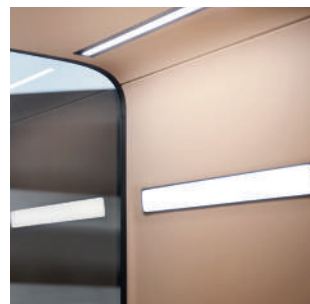

Stylish interior paneling made from sound-absorbing PET material can be easily cleaned and replaced if needed.



Customize your pod to fit your workplace with over 3000 combinations of colors, fabrics, and high-quality materials to choose from.

# Framery One Compact / Colors and finishes



## EXTERIORS

	White RAL 9016 Ultramatt
	Black RAL 9005 Ultramatt
	Gray S 7500 - N Ultramatt
	Navy S 7020 - R90B Ultramatt
	Sand S 2010 - Y20R Ultramatt
	Powder Blue 3421-R86B Ultramatt
	Winter Moss S 7010-G10Y Ultramatt
	Blush 2728-R01B Ultramatt

## CARPETS

	Light Gray Ex-dono Quartet #393330 Fletco carpets
	Dark Blue Zenith #T371880 Fletco carpets
	Champagne Zenith #T371210 Fletco carpets
	Grape Zenith #371680 Fletco carpets





## TABLE TOPS

	White White laminate
	Black Black Laminate with anti-fingerprint surface
	Oak Veneer

## SEATING FABRICS

	Graphite Select #60051 Gabriel
	Dark Blue Select #66144 Gabriel
	Grape Select #61190 Gabriel
	Rose Select #65117 Gabriel
	Powder Blue Select #67098 Gabriel
	Beige Select #61184 Gabriel
	Green Selected #68209 Gabriel
	Mustard Select #62098 Gabriel

## INTERIORS

	Pure Gray Tonal #60123 Gabriel
	Arctic Blue Tonal #66185 Gabriel
	Sand Tonal #61180 Gabriel
	Rouge Tonal #64210 Gabriel

## MATERIALS AND FINISHES



**EXTERIOR PANELS** made from steel feature a powder-coated matt finish. The lightweight panels are joined together seamlessly, with elegant curves that create a timeless design.



**INTERIOR PANELS** made from high-quality and recycled polyester have a vibrant and dynamic look thanks to the mix of the two-colored fabric.

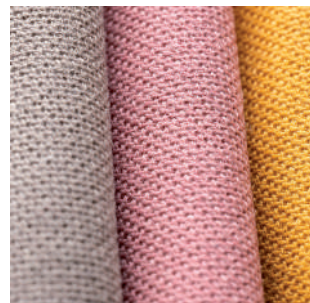

**SEATING MATERIALS** are a blend of superior New Zealand wool and polyamid that form a soft and rich texture. The extremely durable fabrics are both dirt and water repellent.



**CARPET FLOORING** is anti-static, stain resistant, and durable, giving the pod an overall soft look and finish.

---

## Framery workplace technology / Set your office up for success

Framery's workplace technology suite streamlines workdays, elevates productivity, and enhances the entire workplace experience. Access real-time occupancy data, make data-driven decisions, book meeting spaces easily, and boost focus, privacy, and productivity throughout the office. Set up your workplace for the people who use it – making it easier than ever to get work done. And you can enjoy these benefits without any deployment costs.

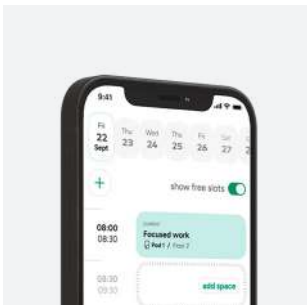

### Framery App™

Manage your workday on the go with the Framery app – the easiest way to book pods and meeting spaces for every task throughout your day. Instantly check space availability and save your favorite spaces to see when they're free. Book spaces in advance or on the go directly from your phone, and manage your entire workday in one place.



### Framery Office Sound Masking System™

The Framery office sound masking system improves the acoustics of the entire workplace. The embedded system is based on patent-pending technology that reduces noise distractions and protects speech privacy in office environments by adding a subtle, unobtrusive background sound outside of the pod. This ambient background noise, similar to air flow, is specifically designed to blend in with the office's noise atmosphere – making sounds less intelligible and therefore less distracting.

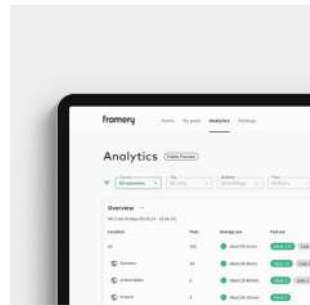

### Framery Connect™

Make workplace management decisions based on insights from your office's occupancy data. Every connected space provides you with valuable usage data you need to improve the layout and efficiency of your workspace. See which spaces are functioning efficiently, which spaces need attention, and which spaces go unused. With real-time usage data you can provide enough spaces in the right places.



### Framery Connect Sensor™

This palm-sized sensor expands the capabilities of Framery Connect – making it possible to collect usage data from any space in your workplace. From meeting rooms to collaborative spaces, the sensor can easily be attached to any space in your office to give you a complete overview of how your office is used. The simple and wireless sensor is equipped with internal 4G connectivity and an external battery boasting a 3-year battery life.

### Unparalleled support

Get instant support from a Framery specialist for any issues that may arise with your smart pods or other products.

### Always updated

Instantly receive software updates through your smart pod's 4G connection to enable developments and services into the future.

### Privacy ensured

No identifiable user data is collected – only workspace occupancy information is tracked.

---

## FRAMERY PLUS – EVERYTHING YOU NEED FOR A SUCCESSFUL WORKPLACE

Unlock all the tools and features your workplace needs to thrive with our subscription based Framery Plus™ – free of charge until the end of 2024.

---

## Framery smart pods / Environmental data sheet

Framery's new smart pods set the standard in sustainability – with durability that is measured in decades, light-weight product structures, use of truly recyclable materials, and modularity that allows the life cycle of the products to be extended indefinitely. Framery participates in the Science Based Targets initiative, and has set emission reduction targets aligned with the goal of limiting global warming to 1.5°C compared to pre-industrial levels. Results of life cycle assessment of Framery products are verified by an independent third party and available in Environmental Product Declarations.



### Optimal material use

Framery has achieved a 23% material reduction with its new line of products – which equals over 1 million kg of raw material annually – while increasing their level of performance compared to previous models. This has made it possible for Framery to reduce product prices as well. The carbon footprint in the manufacturing stage of the new products is 16% smaller on average. A change from plywood to steel as the main construction material also allows Framery to continue reducing its environmental impact and strive towards a 50% reduction in product CO<sub>2</sub> emissions by 2028.



### Production and waste management

All our pods are manufactured in Tampere, Finland using zero-emission electricity. Our factory logistics are operated on biogas and renewable diesel. The material efficiency rate of our production was 94.9% in 2022. Virtually no waste goes to landfill.



### Environmental impact

We have conducted life cycle assessment studies for our products to measure their environmental impacts. Alongside their carbon footprint, we also study other impacts such as resource depletion and water scarcity. The results are verified by an independent third party, and then published and registered as an EPD to provide stakeholders with reliable information on our products' environmental performance in a transparent way.



### Product performance

The modular design of our pods facilitates a long product lifetime, and our customers typically use them for many years. The same pod can be used by one customer after another, enabling multiple life cycles and saving valuable resources. Thanks to their modular design, our pods are easy to disassemble, refurbish if needed, and reassemble at a new location. Our products are GREENGUARD Gold certified, and highly maintainable with easily available spare parts.



### Extended life cycles

The most effective way for manufacturers to reduce the environmental impact of their products is to extend their life cycle. The durability of the all-steel structures of Framery's new products is measured in decades. Modular product structures allow the pods to be easily serviced and refurbished, extending their life cycles even further. At the end of their life, the products are fully recyclable as a result of eliminating composite and other hard-to-recycle materials.



### Transportation

Logistical hubs in Singapore and the USA reduces air freight, and allows us to load our shipping containers more tightly. The products are made-to-order, and their modularity helps us achieve this with minimal impact.



# Framery One Compact™

## Technical specifications

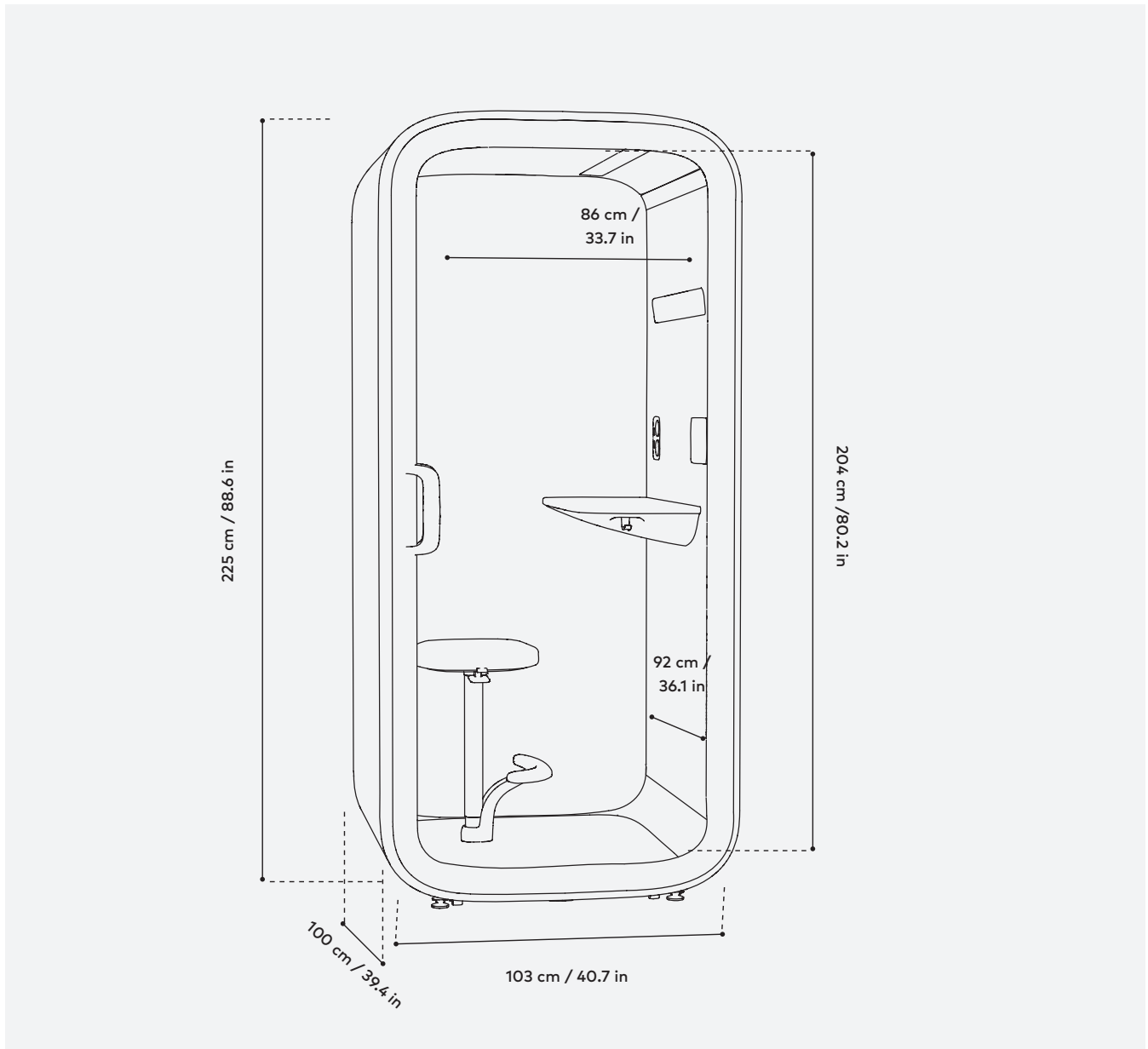

### Performance

Speech level reduction: 30dB  
Maximum airflow: 36 l/s  
Low energy consumption: 27W

### Sustainable design

Built to last for decades  
Light-weight product structures  
EOL 100% recyclable materials  
Refurbishable & movable

### Connectivity

Built-in 4G connection  
Automatic software updates  
Framery Connect digital services

# Framery One Compact / Technical specifications

## OVERVIEW

Soundproofing	<b>CLASS A 30 DS,A (dB) reduction</b> Speech level reduction DS,A (dB) is measured using ISO 23351-1. Pod can be placed next to workspaces without compromising privacy.
Sound masking	<b>FRAMERY OFFICE SOUND MASKING SYSTEM™</b> A pre-fitted sound masking system improves the soundscape of the office outside the pods with an effective radius of 5 m / 16 ft.
Ventilation	<b>MAXIMUM AIRFLOW 36 l/s, 76 CFM (129.6 m<sup>3</sup>/h)</b> <b>DEFAULT AIRFLOW 26 l/s, 55 CFM (94 m<sup>3</sup>/h)</b> when in use. After use, the pod refreshes itself with a higher ventilation speed. <b>STANDBY MODE 16 l/s, 34 CFM, (58 m<sup>3</sup>/h)</b>
Lighting	<b>CEILING LIGHT</b> Color temperature 4000K, illuminance up to 500lux on the table top. <b>VIDEO LIGHT</b> Color temperature 4000K, illuminance up to 400lux on the user's face. <b>PRE-SET LIGHTING MODES</b> Standard mode & Video call mode. Lighting can also be adjusted manually.
Presence detection	<b>SENSOR TECHNOLOGY</b> mmWave radar
Dimensions	<b>EXTERIOR 225 × 103 × 100cm / 88.6 × 40.7 × 39.4 in (h,w,d)</b> <b>WITH CASTERS</b> Additional 0,5 cm / 0.2 in (h) <b>DOORWAY 204 × 85cm / 80.2 × 33.5 in (h, w)</b> <b>WEIGHT 253 kg / 558 lb</b>
Connectivity	Built-in 4G with Framery provided SIM card Wi-Fi 802.11 a/b/g/n/ac 2.4&5 GHz Over-the-air software updates Framery Connect services available

## DIMENSIONS / MAIN VIEW

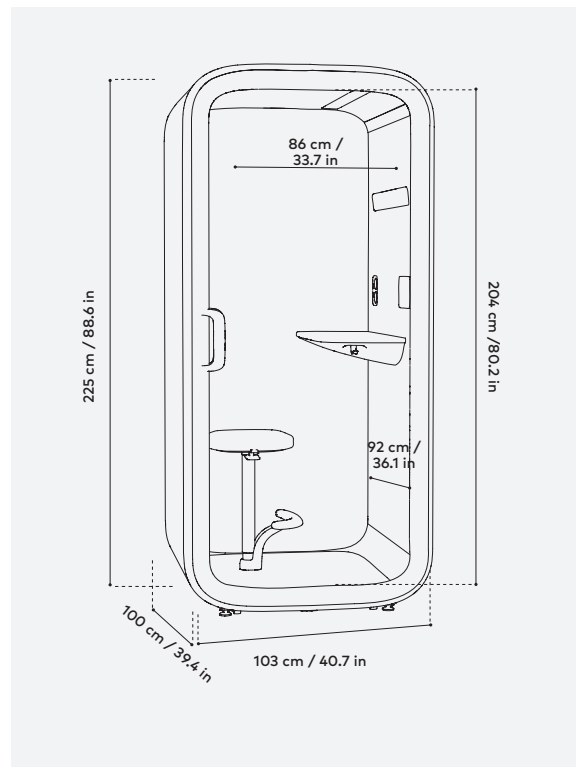

Framery One Compact is UL GREENGUARD GOLD certified



Framery One Compact shipped in North America is UL 962 listed

# Framery One Compact / Technical specifications

## MATERIALS

**Exterior & structure**

**EXTERIOR PANELS** Powder coated matt steel panels  
**FRAMES** Structure matt black aluminum  
**DOOR FRAME** Matt black aluminum and plastic structure  
**GLASS** Sound control laminated glass (4 + 4 mm / 0.16 + 0.16 in)  
**CHASSIS** Light steel and PET sound-absorbing structure  
**HANDLE** Mix of black plastic and steel

**Interior materials**

**INTERIOR PANELS** PET sheets laminated with recycled polyester fabric  
**UPHOLSTERY FABRIC** Gabriel Tonal  
**CARPET** Antistatic and stain resistant low loop pile carpet  
**TABLE** Table top is birch plywood laminated with white, black anti-fingerprint, or oak veneer. The table bottom is black thermoformed felt.

**Seating materials**

**UPHOLSTERY FABRIC** Gabriel Select  
**FABRIC COMPOSITION** 85 % New Zealand wool / 15 % Polyamide  
**LEG & FOOTREST** Steel and aluminum

**Furniture dimensions**

**TABLE SIZE** 76.5 x 36 cm / 30 x 14 in (w, d)  
**TABLE HEIGHT** 102 cm / 40.2 in  
**MAX LOAD FOR THE TABLE** 50 kg / 110 lb

**SEAT SIZE** 38 x 38 cm / 15 x 15 in (w, d)  
**SEAT HEIGHT** 59–85 cm / 23.2–33.5 in  
**MAX LOAD FOR THE SEAT** 135 kg / 300 lb

## DIMENSIONS / TOP VIEW

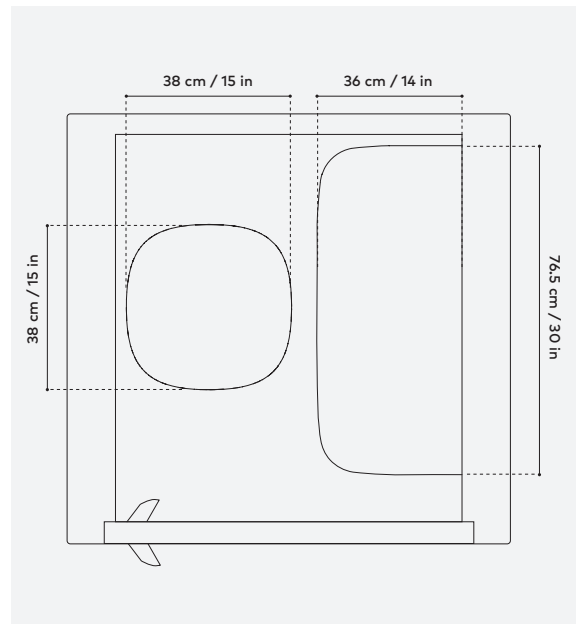

## SAFETY

**Fire safety**

No fire hazardous materials are used in Framery pods. The fire safety of all surface materials, upholstery and acoustics materials of our products are tested and classified by either national or international standards. Framery provides additional safety measurements to adhere to local regulatory requirements.

**Seismic safety**

A seismic anchoring kit for a pod is available for the seismic regions. The kit consists of brackets that further reinforce the pod structure to withstand heavy seismic forces.

# Framery One Compact / Technical specifications

## POWER AND SPACE REQUIREMENTS

Power	<p><b>OUTLETS</b> 1 × power outlet Optional: 1 × power outlet, 1-2 × USB-C PD charge ports (65W) or 1 × LAN port (with cable)</p> <p><b>POWER CONSUMPTION</b> Default settings 27W. Highest settings 40W. Standby mode 14W.</p> <p><b>INPUT</b> 100–240 VAC, 10 A, 50–60 Hz</p> <p><b>OUTPUT AC (POWER OUTLET)</b> 100–240VAC, 6.6A, 50–60 Hz</p> <p><b>OUTPUT USB-C PD CHARGE PORT</b> 65W</p>
Space requirements	<p><b>DOOR OPENING RATIO</b> 180°</p>
Door handedness	<p>Right-handed by default (can also be installed left-handed)</p>
Operating space	<p>235 × 104 × 192.5 cm / 92.5 × 40.9 × 75.7 in (h, w, d). For seismic anchoring leave 50 cm / 19.7 in of free space outside of exterior panel walls. For sprinkler installation requirements leave 50 cm / 19.7 in of free space on the outside of the table wall.</p>

## SHIPPING CRATE

Dimensions	228.5 × 112 × 86.5 cm / 90 × 44.1 × 34 in
Weight	310 kg / 683 lb Crates can be stacked (max 3 boxes)

## DIMENSIONS / POWER CORD SPECIFICATIONS

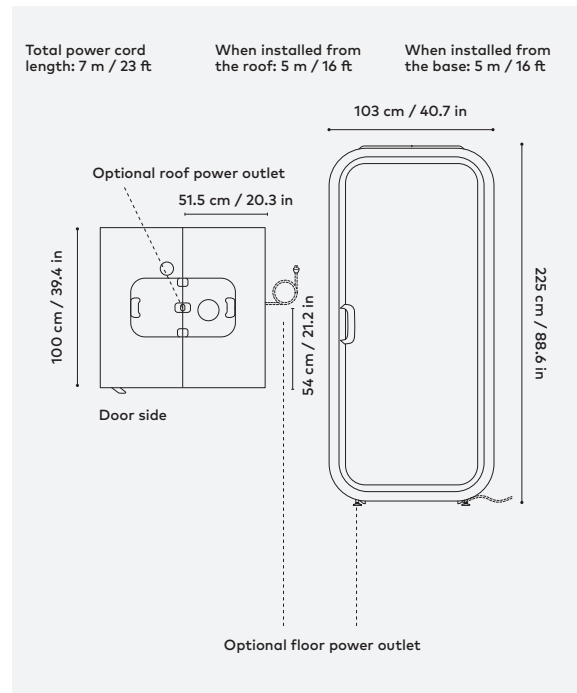

## DIMENSIONS / OPERATING DIMENSIONS

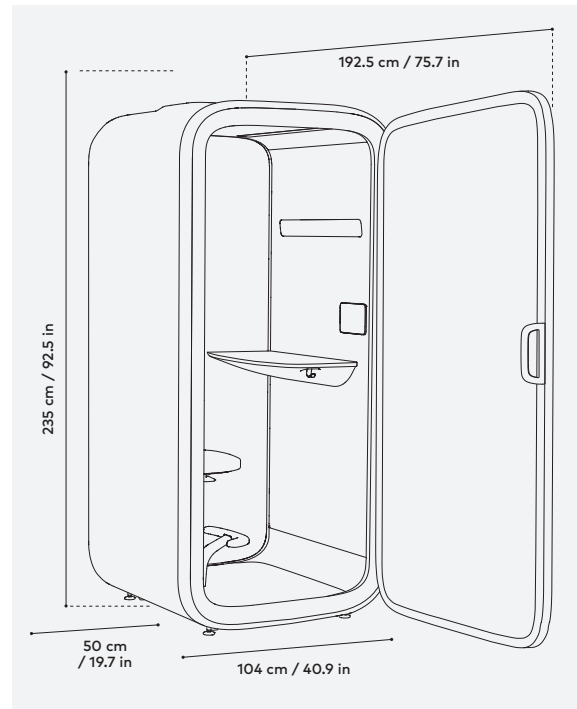

For the doers,  
leaders, thinkers,  
dreamers, creators,  
teams, pioneers  
and innovators.  
**For people who  
get it done.**