



Colección modular soft seating de formas sinuosas y generosas dimensiones, con infinitud de opciones en sus modelos ideal para crear espacios multifuncionales y atractivos en todo tipo de entornos: lobbies, zonas de espera y contract, áreas comunes, oficinas...

Del diálogo entre la precisión de la geometría y la libertad de la experimentación nace esta colección con un discurso contemporáneo y abierto a un sinfín de posibles composiciones diseñadas para vestir espaciosos ambientes que marcan un estilo de vida.

Con el tapizado como protagonista posibilita tanto las bancadas de asientos sin respaldo, como los sofás de dos y tres plazas, o las butacas y pufs de una plaza modulares que permite la unión de sus piezas. Su estructura metálica de cuatro patas pintada en cualquiera de los colores de muestrario posibilita la customización de cada proyecto.

Modular soft seating collection with sinuous shapes and generous dimensions, with an infinite number of options in its models, ideal for creating multifunctional and attractive spaces in all types of environments: lobbies, waiting and contract areas, common areas, offices...

From the dialogue between the precision of geometry and the freedom of experimentation is born this collection with a contemporary discourse and open to endless possible compositions designed to dress spacious environments that mark a lifestyle.

With the upholstery as the protagonist, it makes it possible to create backless seating benches, two- and three-seater sofas, or modular armchairs and one-seater poufs that allow the union of its pieces. Its four-legged metal structure, painted in any of the sample colors, makes it possible to customize each project.

### Sillón 1 plaza / 1 seat sofa

### Dimensiones y peso / Dimensions and weight

#### TRS1P2

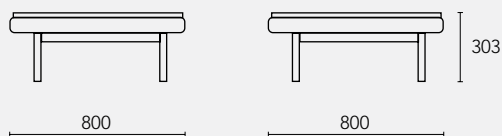

#### TRS1P0

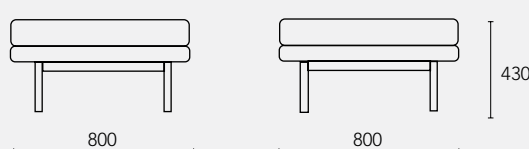

#### TRS1P1

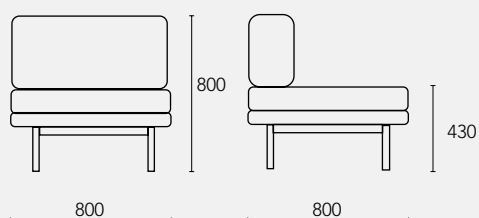

W Anchura / Width; H Altura / Height; D Profundidad / Depth; S Altura hasta asiento / Height up to seat.

## Sillon 2 plazas / 2 seat sofa

Dimensiones y peso / Dimensions and weight

### TRS2P1R / TRS2P1L

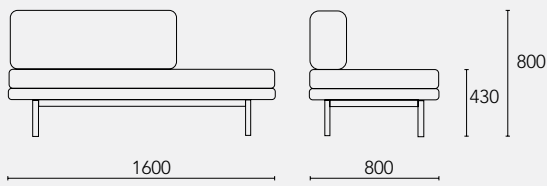

### TRS2P12L / TRS2P12R

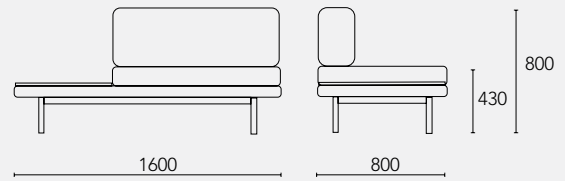

### TRS2P0

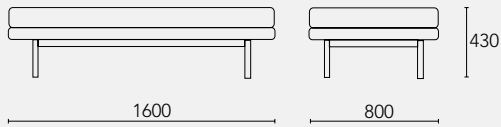

### TRS2P02

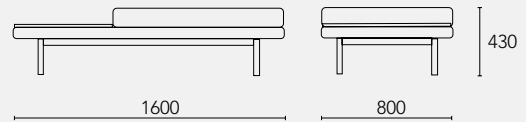

## Sillón 3 plazas / 3 seat sofa

Dimensiones y peso / Dimensions and weight

### TRS3P1R / TRS3P1L

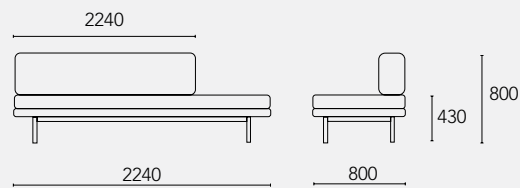

### TRS3P12R / TRS3P12L

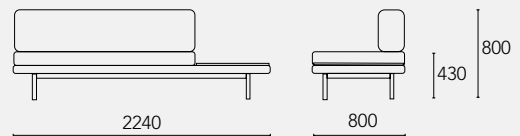

### TRS3P0

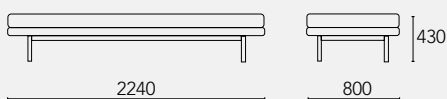

### TRS3P02

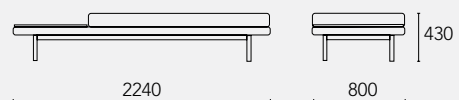

## Sillón curvo / Curved sofa

Dimensiones y peso / Dimensions and weight

### TRC2P1

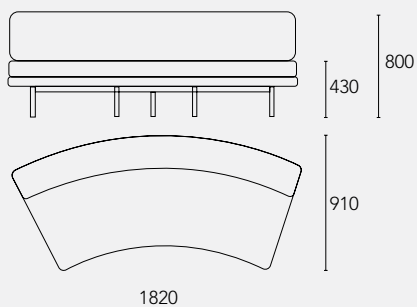

### TRC2P0

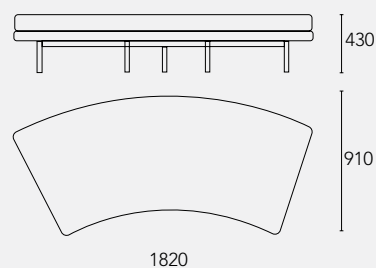

W Anchura / Width; H Altura / Height; D Profundidad / Depth; S Altura hasta asiento / Height up to seat.

## ASIENTO Y RESPALDO / SEAT AND BACKREST

Canto regresado para base tapizada fabricada en DM de 40x60 mm unido a tablero de chopo de 19 mm. Estructura interior de asiento fabricada en tablero de DM 10 mm. Revestido con espumas flexibles de PU de 110 mm de espesor. Esta tapizado en dos piezas independientes, base y asiento, unidas entre sí.

Respaldo en tablero de DM 10 mm y tubos metálicos de unión de Ø25 mm con herrajes de fijación revestido de espuma flexible de PU de 180 mm de espesor.

Tanto asiento como respaldo están recubiertos de manta de fibra.

Estas butacas modulares se presentan en formato de 1, 2 y 3 plazas más un modelo curvo que aporta funcionalidad a cualquier composición.

Thickened edge for upholstered base made of 40x60 mm MDF joined to 19 mm poplar board. Interior seat structure made of 10 mm MDF board. Covered with 110 mm thick flexible PU foam. It is upholstered in two independent pieces, base and seat, joined together.

Backrest in 10 mm MDF board and Ø25 mm metal connecting tubes with fixing hardware covered in 180 mm thick flexible PU foam. Both the seat and backrest are covered with fibre blanket.

These modular armchairs are available in 1, 2 and 3-seater formats plus a curved model that adds functionality to any composition.

## ESTRUCTURAS METÁLICAS / METALLIC STRUCTURES

Bastidor metálico en tubo de acero rectangular 60x20 mm y 4 patas fabricadas en tubo de acero de Ø25 mm y pintado en epoxi en colores del muestrario. Esta estructura da soporte al asiento y respaldo.

Ángulo plegado y soldado en chapa de 2mm de espesor soldados al bastidos que permiten su unión con la madera de la base.

El sistema modular permite incorporar sobre la base tapizada tapas de mesas.

Metal frame in rectangular steel tube 60x20 mm and 4 legs made of steel tube Ø25 mm and painted in epoxy in the colours of the sample book. This structure supports the seat and backrest.

Folded and welded angles in 2 mm thick sheet metal welded to the base that allow it to be joined to the wood of the base.

The modular system allows the incorporation of table tops on the upholstered base.

## TAPAS DE MESA / TABLE TOPS

El sistema ofrece módulos con mesa incluida sobre la propia base tapizada, siendo de 790x790 mm en el caso de la butaca de una plaza, y de 650x790 mm en el caso del resto de módulos.

Las tapas se ofrecen en contrachapado de 13 mm con revestimiento en estratificado de color: roble claro, Antracita antihuella y Negro infinity antihuella.

The system offers modules with table included on the upholstered base itself, measuring 790x790 mm in the case of the one-seater armchair, and 650x790 mm in the case of the rest of the modules.

The tops are available in 13 mm plywood with stratified covering in the following colours: light oak, Anthracite anti-fingerprint and Black infinity anti-fingerprint.

## ACABADOS DE LAS ESTRUCTURAS METÁLICAS / METALLIC STRUCTURES FINISHES

### ESTÁNDAR / STANDARD



RAL 9005  
Negro (N)  
Black

RAL 9016  
Blanco (B)  
White

### COLORES (liso semibrillo) / COLORS (Semi-gloss smooth)



RAL 1013  
Oyster White  
(OW)

RAL 1019  
Visión (VI)  
Mink

RAL 1032  
Mostaza (MO)  
Mustard

RAL 3003  
Rojo (RO)  
Red

RAL 5014  
Celeste (CE)  
Light Blue

RAL 5020  
Verde Oceano  
(VO)  
Ocean Green

RAL 7004  
Gris (GR)  
Grey

### COLORES (Texturado) / COLORS (Textured)



RAL 5011  
Blue Night  
(BN)

RAL 6005  
Moss Green  
(MG)

RAL 7016  
Anthracite  
(AN)

### COLORES (Liso semimate) / COLORS (Semi-matte Smooth)

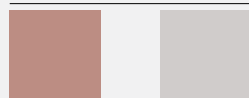

NCS 3020 Y80R  
Powder (PO)

NCS 3502-R  
Light Grey (LG)

### Metalizados / Metallized



Gold (smooth)  
NEW

Copper  
(Textured)

Silver (smooth)  
RAL 9006

## ACABADOS DE TAPAS DE MESAS / TABLE TOP FINISHES

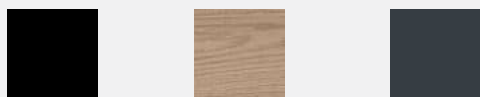

Negro / Black

Roble Claro /  
Light Oak

Antracita /  
Anthracite

## TAPICERÍA / UPHOLSTERY

La colección Track puede ser tapizados en cualquiera de los tejidos incluidos en el muestrario Mobboli, incluso en tapicerías adecuadas aportadas por el cliente.

The Track collection can be upholstered in any of the fabrics included in the Mobboli sample, even in suitable tapestries provided by the customer.

## NORMATIVAS Y CERTIFICADOS / REGULATIONS AND CERTIFICATES

Proceso de fabricación bajo certificado de gestión de calidad UNE EN ISO 9001:2015, medioambiente UNE EN ISO 14001:2015.

· Ficha de reciclabilidad que contempla el estudio de los menores impactos medioambientales del producto a lo largo de su ciclo de vida.

Manufacturing process under quality management certificate UNE EN ISO 9001: 2015, environment UNE EN ISO 14001: 2015.

· Recyclability sheet that includes the study of minors environmental impacts of the product throughout its cycle of life.



## GARANTÍA / WARRANTY

Mobboli ofrece una garantía de 5 años contra todo defecto de fabricación sin incluir los daños ocasionados por un uso inadecuado ni los propios del desgaste por uso o accidente. Quedan excluidos también de la garantía los daños ocasionados por un mantenimiento o limpieza inadecuada. Quedan excluidas de la garantía las roturas y manchas de tapicería.

Deberá acreditar la fecha de compra del producto con la factura correspondiente y con fotografía del N° etiqueta calidad.

Mobboli offers a 5-year warranty against manufacturing defects, not including damage caused by improper use or damage caused by wear or accident. Damages caused by improper maintenance or cleaning are also excluded from the warranty. Breaks and stains of upholstery are excluded from the warranty.

It must prove the date of purchase of the product with the corresponding invoice and with a photograph of the quality label number.

## COLECCIÓN / COLLECTION



**TRS1P2**

Mesa  
Table



**TRS1P0**

Modulo puf 1 plaza  
1 seat pouf module



**TRS1P1**

Modulo de una plaza con  
respaldo  
1seat module with  
backrest



**TRS2P0**

Modulo puf de 2 plazas  
2 seat pouf module



**TRS2P02**

Modulo puf 2 plazas con  
mesa  
2 seat pouf module with  
table



**TRS2P1R/TRS2P1L**

Modulo de 2 plazas con  
respaldo  
2 seat pouf module with  
backrest



**TRS2P12R/TRS2P12L**

Modulo de 2 plazas con  
respaldo y mesa  
2 seat pouf module with  
backrest and table



**TRS3P0**

Modulo puf de 3 plazas  
3 seat pouf module



**TRS3P02**

Modulo puf 3 plazas con  
mesa  
3 seat pouf module with  
table



**TRS3P1R/TRS3P1L**

Modulo de 3 plazas con  
respaldo  
3 seat pouf module with  
backrest



**TRS3P12R/TRS3P12L**

Modulo de 3 plazas con  
respaldo y mesa  
3 seat pouf module with  
backrest and table



**TRC2P0**

Modulo puf 2 plazas curvo  
2 seat curved module pouf



**TRC2P1**

Modulo 2 plazas curvo con  
respaldo  
2 seat curved module with  
backrest

**TRC**

Cojín tacto blando  
Soft touch cushion  
500x450x150mm

---

## OPCIONES / OPTIONS

Todas las butacas y sillones de la colección, pueden incorporar brazo izquierdo o derecho de forma opcional. Este brazo consta de los mismo elementos que el respaldo y comparte su misma altura y ancho.

All the armchairs in the collection can optionally incorporate left or right armrests. This armrest consists of the same elements as the backrest and shares the same height and width.

# ¿Necesitas ayuda con tu proyecto?



914 479 577



[lambdatres@lambdatres.com](mailto:lambdatres@lambdatres.com)



C/ Laguna de Cameros 8  
28021 Madrid.



[lambdatres.com](http://lambdatres.com)



**CONTÁCTANOS** 



**LAMBDA3**  
INSPIRANDO ESPACIOS DE TRABAJO